

**Product Feature:**

- ◆ Input Voltage: 108~305Vac;
- ◆ Surge immunity: DM-4KV, CM-6KV;
- ◆ THD<10%;
- ◆ Protection: Input OVP, Output OVP, SCP, OTP;
- ◆ IP67 design for indoor and outdoor applications;
- ◆ 5 years warranty.

Application

- ◆ LED street lighting, industrial lighting and landscape lighting.

DESCRIPTION

The EHC-042W is a 42W, constant-current, IP67 LED driver that operates from 108-305 Vac input with excellent power factor and low THD. It is created for industrial lights, tunnel and street lights. The high efficiency of these drivers and compact metal case enable them to run cooler, significantly improving reliability and extending product life. To ensure trouble-free operation, protection is provided against input surge, input over voltage, output over voltage, short circuit, and over temperature.

Models

Model Number	Input voltage range(Vac)	Max Output Power (W)	Output Voltage Range (Vdc)	Output current (A)	Typical Efficiency	Typical THD	Typical PF	
							120Vac	230Vac
EHC-042B084	108-305	42W	42-84	0.50	88%	10%	0.99	0.97
EHC-042B060	108-305	42W	30-60	0.70	88%	10%	0.99	0.97
EHC-042B049	108-305	42W	25-49	0.86	87%	10%	0.99	0.97
EHC-042B040	108-305	42W	20-40	1.05	87%	10%	0.99	0.97

Remark: All specifications are measured at 25°C ambient temperature, if no specific note.

INPUT SPECIFICATIONS

Parameter	Min.	Typ.	Max.	Notes
Input Voltage	108Vac	120-277Vac	305Vac	Please refer to the Derating curve
Input Frequency	47Hz	50/60	63Hz	
Leakage Current	-	-	0.75mA	240V/60Hz
Input AC Current	-	-	0.60A	120-277Vac with full load
Inrush Current (I _{rt})	-	-	0.01A ² S	230Vac input, Ta=25°C (cold start)
Power Factor	0.95	0.97	-	230Vac with full load
THD	-	-	20%	120-277Vac with 70%-100% load
THD	-	10%	15%	120~230Vac with full load

OUTPUT SPECIFICATIONS

Parameter	Min.	Typ.	Max.	Notes
Output Current Tolerance	-8%I _{set}	-	8%I _{set}	Full load
Total Output Current Ripple (pk-pk)	-	150%	200%	Full load & LED Load, ripple is different with difference LED load. 20MHz BW
Startup Overshoot Current	-	-	10%	120~277Vac & Full load, LED Load
No Load Output Voltage EHC-042B084 EHC-042B060 EHC-042B049 EHC-042B040	-	-	100V 80V 80V 70V	
Line Regulation	-	-	±8%	25°C±10°C ambient temperature, input voltage changes from 120Vac to 277Vac.
Load Regulation	-	-	±8%	25°C±10°C ambient temperature, 230Vac input, load changes from 60% to 100%.
Turn-on Delay Time	-	-	3S	120Vac, 100% load
	-	0.5S	1S	230Vac, 100% load

GENERAL SPECIFICATIONS

Parameter	Min.	Typ.	Max.	Notes	
Efficiency @120Vac					
EHC-042B084	85%	86%		Measured at full load and 25°C ambient temperature	
EHC-042B060	85%	86%			
EHC-042B049	84%	85%			
EHC-042B040	84%	85%			
Efficiency @230Vac					
EHC-042B084	87%	88%		Measured at full load and 25°C ambient temperature	
EHC-042B060	87%	88%			
EHC-042B049	86%	87%			
EHC-042B040	85%	87%			
Efficiency @277Vac					
EHC-042B084	86%	87%		Measured at full load and 25°C ambient temperature	
EHC-042B060	86%	87%			
EHC-042B049	85%	86%			
EHC-042B040	84%	86%			
Dielectric Strength	Input-Output	-	3750Vac	-	10mA/60S
	Input-PE	-	1600Vac	-	
	Output- PE	-	1600Vac	-	
Grounding Resistance	-	-	0.1Ω	25A/60S	
Insulation Resistance	50MΩ	-	-	Input-Output, Input-PE, Output-PE, 500Vdc/60S/25°C/70%RH	
MTBF	-	200000Hours	-	230Vac,80% load (MIL-HDBK-217F)	
Lifetime	-	50000Hours	-	230Vac&100% load,70°C case temperature, refer to lifetime VS Tc curve for details	
Operating Case Temperature for Safety Tc_s	-40°C	-	+90°C		
Operating Case Temperature for Warranty Tc_w	-40°C	-	+75°C	5 Years Warranty Humidity: 10% to 95% RH	
Storage Temperature	-40°C	-	+90°C	Humidity: 10% to 95% RH	
Dimensions (LxWxH)mm	104*64*33mm				
Net Weight	360±50g/PCS				
Package	L480xW275xH208mm; 24pcs/ctn.				

Note: All specifications are tested by Cree XLamp XP-G2 and typical measured at 230Vac and 25°C unless otherwise stated.

SAFTY STANDARDS

Safety Category	Country / Territory	Standards
CCC	China	GB19510.1, GB19510.14
CE	China	EN61347-1, EN61347-2-13
CB	CB Countries	IEC61347-1, IEC61347-2-13
BIS	India	IS 15885(PART 2/SEC 13)
UL	USA	UL 8750
CUL	Canada	CSA C22.2 No.250.13
KC	South Korea	K61347-1, K61347-2-13, K62384
PSE	Japan	J61347-1, J61347-2-13
SAA	Australia	AS/NZS IEC 61347-2-13
		AS/NZS 61347.1

EMC COMPLIANCE

EMC Category	Country / Territory	Standards
CCC	China	GB 17743, GB 17625.1
CE	Europe	EN 55015, EN 61000-3-2, EN 61000-3-3
		EN61000-4-2,3,4,5,6,8,11
		EN 61547
KC	South Korea	K61547
		K00015
PSE	Japan	J55015
FCC	USA	FCC part 15

NOTE:

This LED driver meets the EMI specifications above, but EMI performance of a luminaire that contains it depends also on the other devices connected to the driver and on the fixture itself.

INRUSH CURRENT WAVEFORM

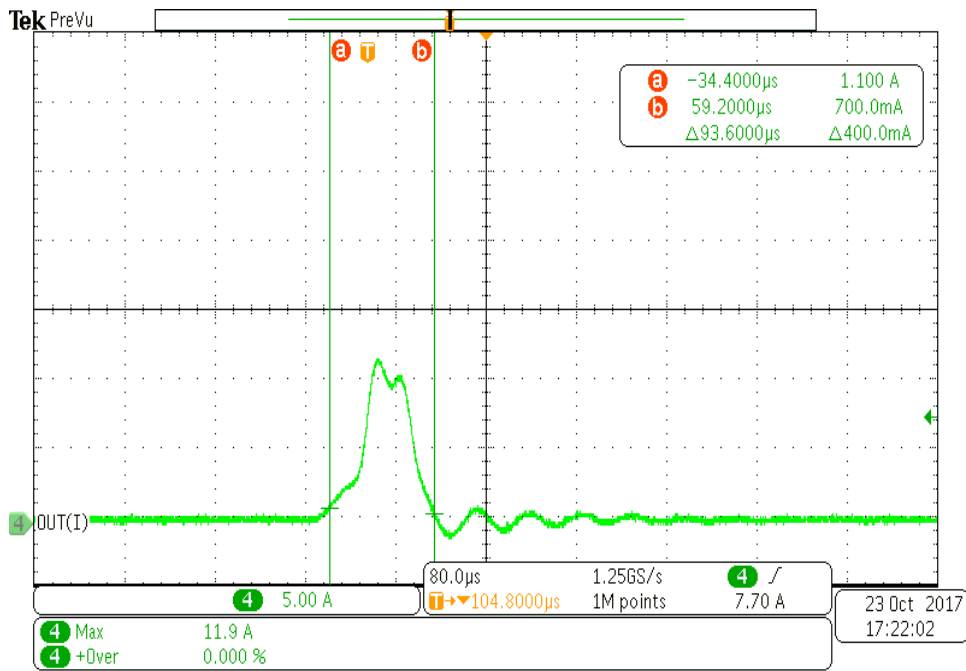

DERATING CURVE

Derating Curve

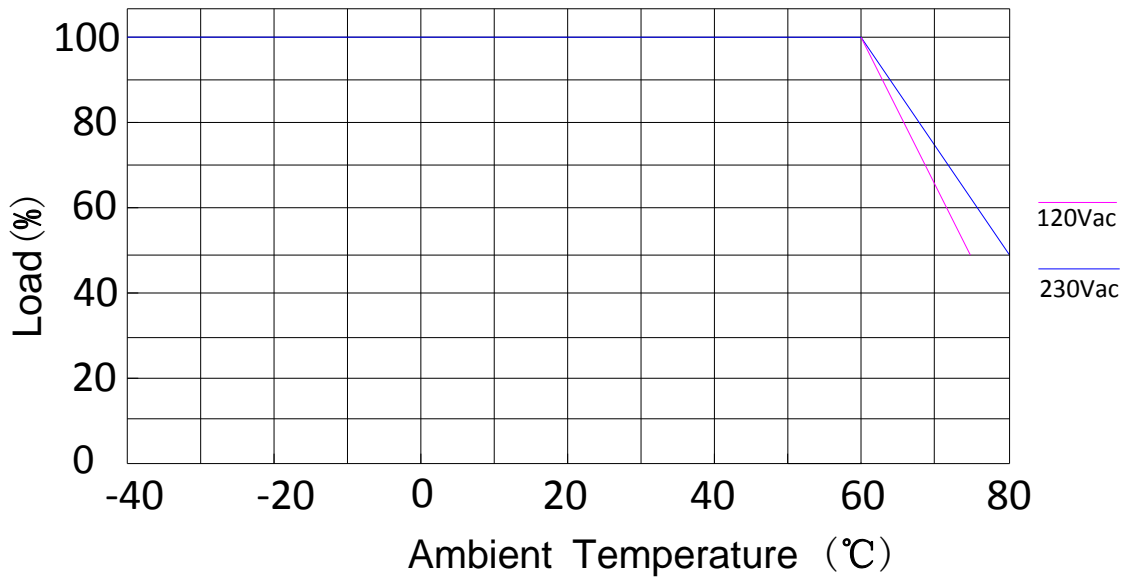

OUTPUT POWER VS INPUT VOLTAGE

Output power VS. Input voltage curve

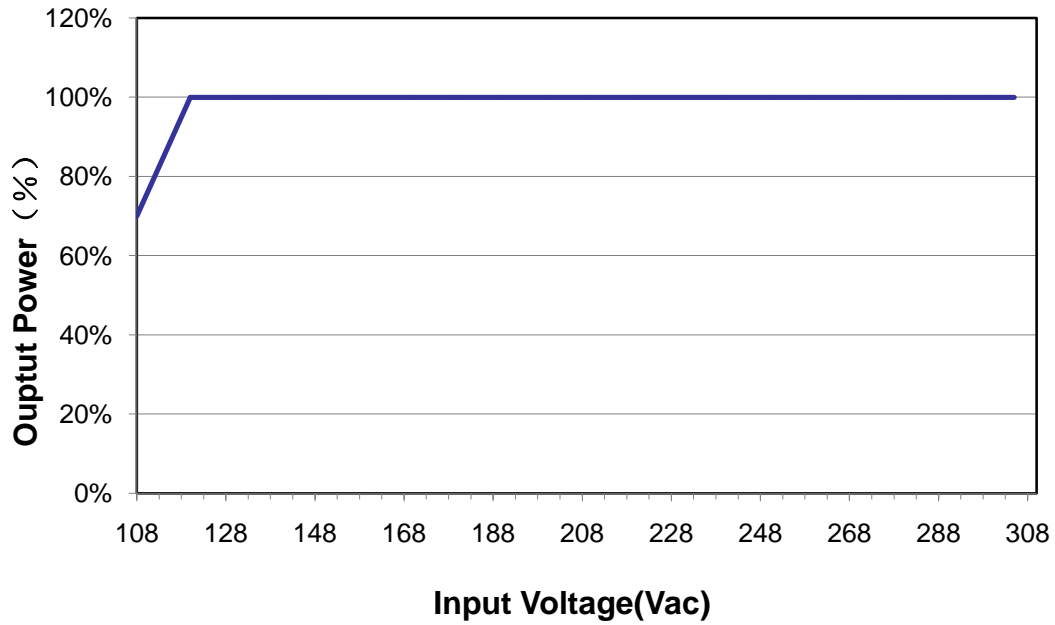

LIFETIME VS CASE TEMPERATURE

Life Time VS. Temperature Curve

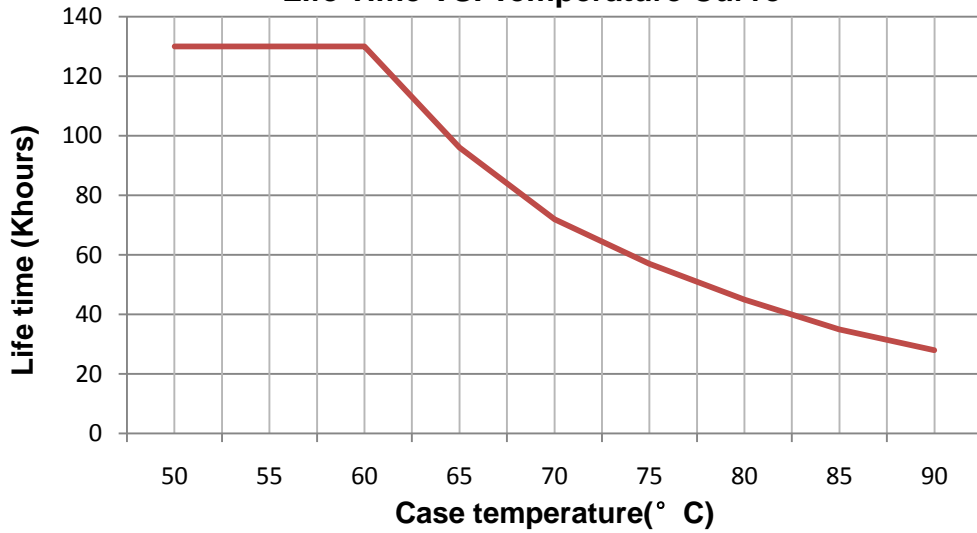

EFFICIENCY VS LOAD

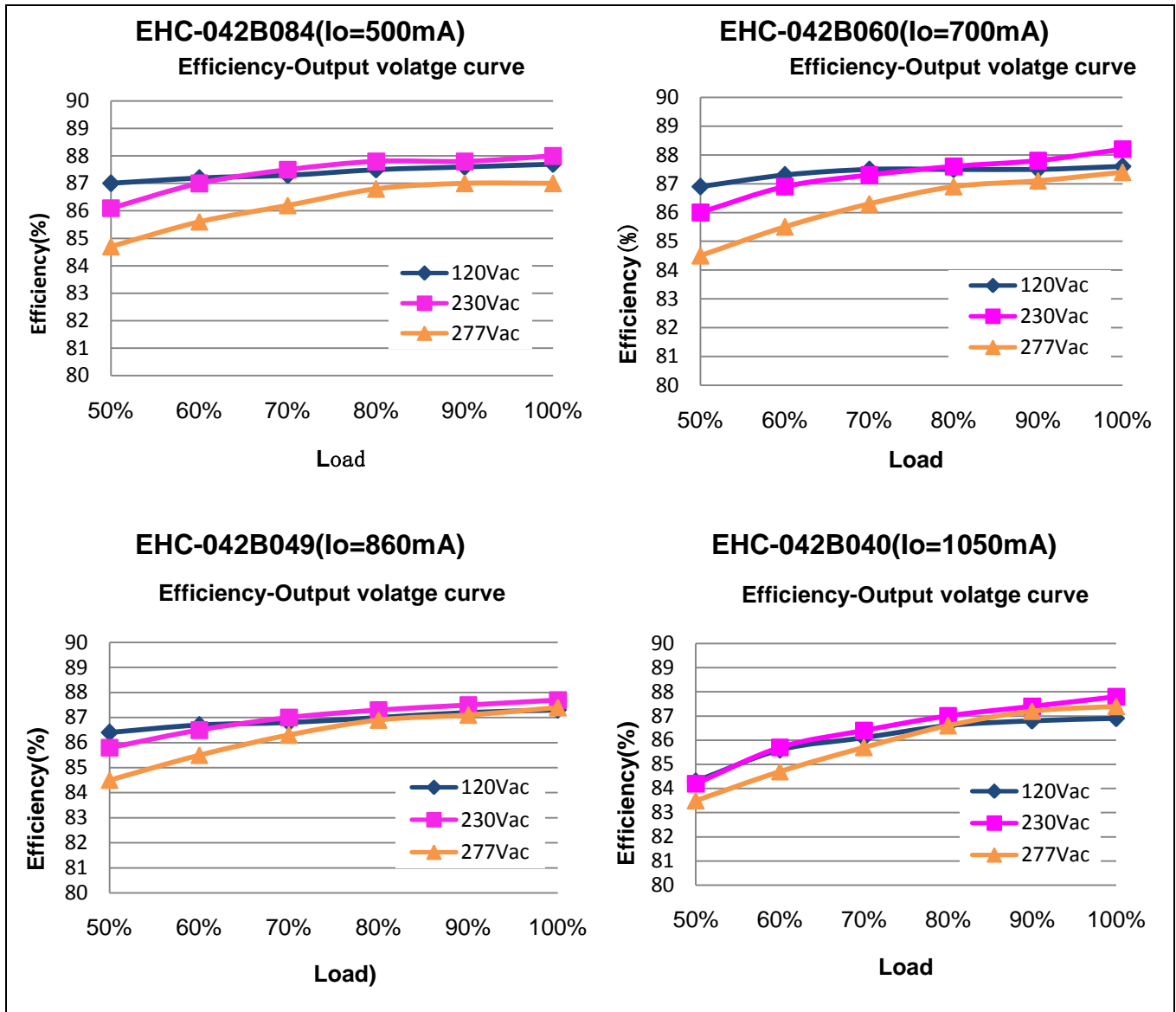

POWER FACTOR VS LOAD

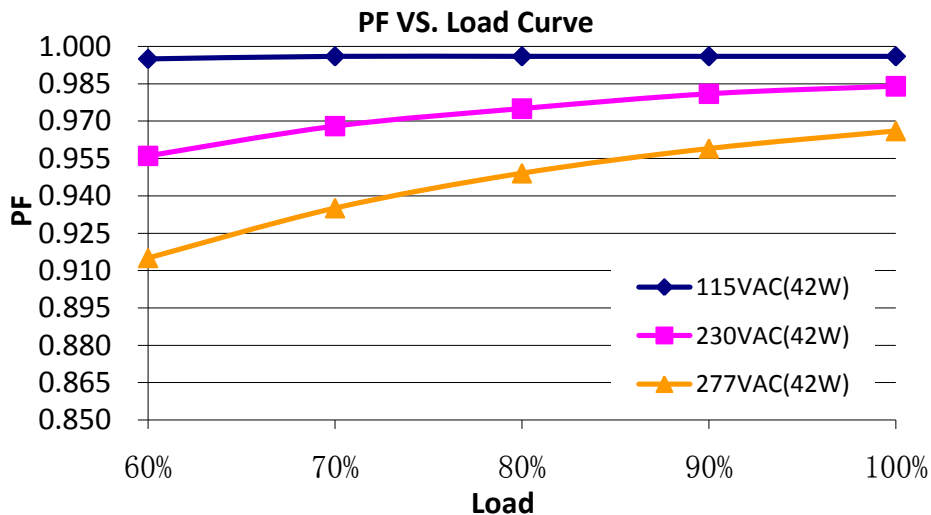

TOTAL HARMONIC DISTORTION

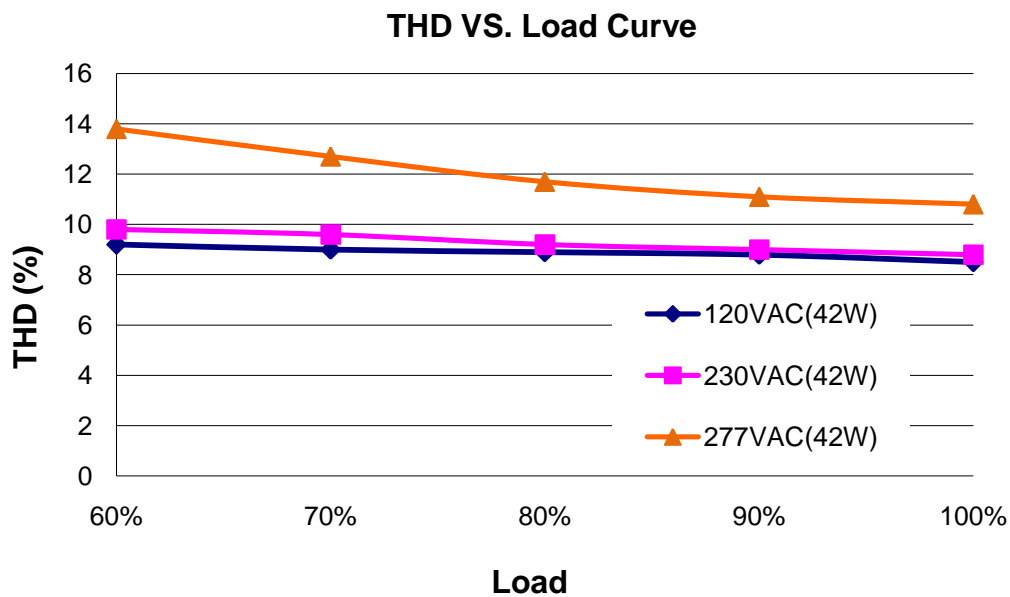

PROTECTIONS

Parameter		Min.	Typ.	Max.	Notes
Input Over Voltage Protection(output 0.5A-0.86A)	Input Protection Voltage	320Vac	330Vac	340Vac	Turn off the output when the input voltage exceeds protection voltage.
	Recovery Voltage	300Vac	320Vac	340Vac	Auto Recovery. The driver will restart when the input voltage falls below recovery voltage.
	Max. of Input Over Voltage	-	-	440Vac	The driver can survive for 48 hours with input over-voltage of 440Vac.
Input Over Voltage Protection(output 1.05A)	Input Protection Voltage	345Vac	350Vac	355Vac	Turn off the output when the input voltage exceeds protection voltage.
	Recovery Voltage	330Vac	340Vac	350Vac	Auto Recovery. The driver will restart when the input voltage falls below recovery voltage.
	Max. of Input Over Voltage	-	-	440Vac	The driver can survive for 48 hours with input over-voltage of 440Vac.
Short Circuit Protection		Hiccup mode and auto recovery. No damage will occur when any output is short circuited. The output shall return to normal when the fault condition is removed.			
Output Over Voltage Protection		Limits output voltage at no load and in case the normal voltage limit fail			

MECHANICAL OUTLINE

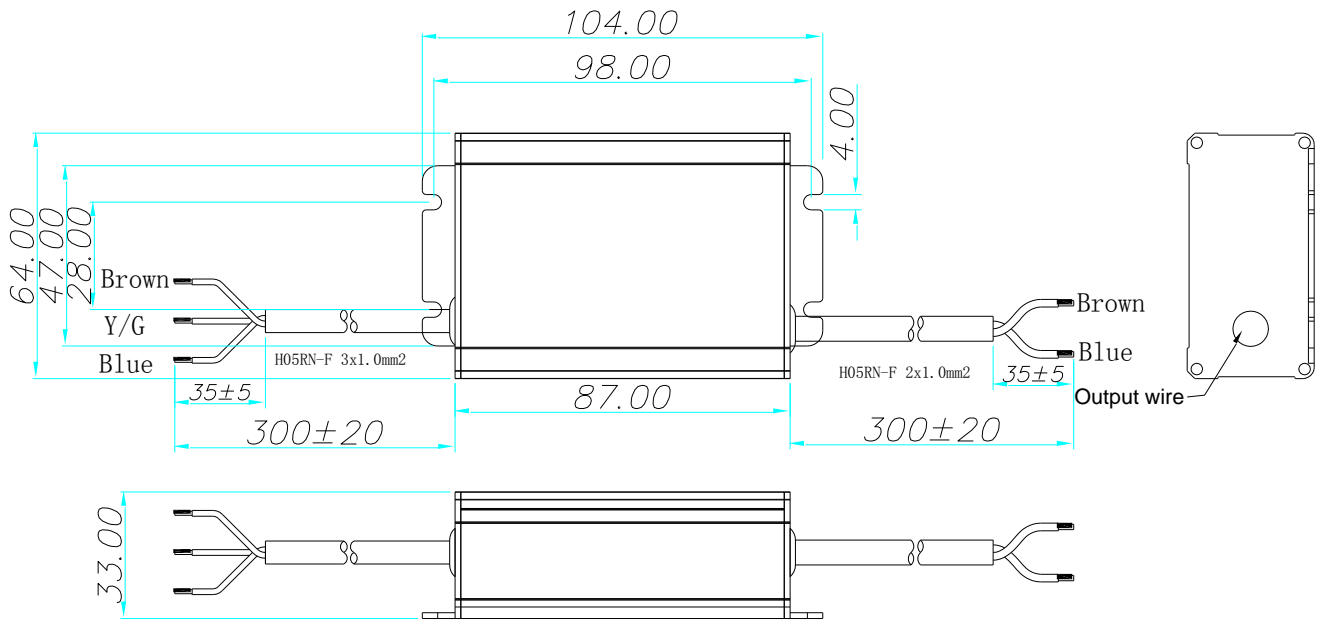

REVISION HISTORY

Version	Description of Change		Date	Notes
	Before	Now		
A.2	—	Datasheets Release	2018-03-13	